



Lighting

Designed through innovation







ABOUT US

We at Sensio have been designing lighting solutions for kitchens and bedrooms since 2007. With a clear focus on quality and innovation, we are changing the industry from the inside out through the development of new concepts and technologies that are exclusive to us. Winners of multiple design awards, industry approved and certified; Sensio is a family owned brand you can trust.

Innovation, Create, Illuminate.



Sensio Lighting Ltd



Sensio America LLC



Sensio Company (HK) Ltd



Sensio Slovenia D.O.O

DESIGN, QUALITY & SERVICE

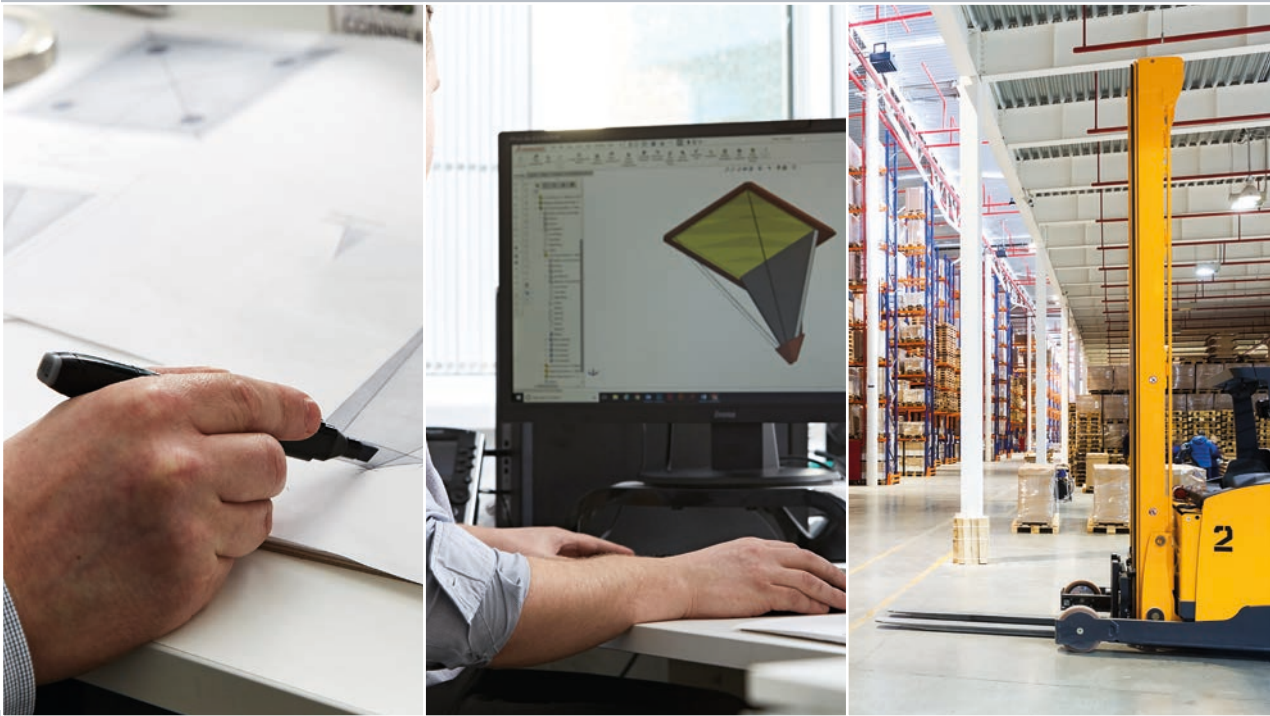

We place our focus on doing things a little differently. We are dedicated to designing and developing new and innovative lighting solutions that meet various design requirements. Our range of multi-award winning products offer the very latest LED technology and features that will help you exceed your customers expectations when designing their new kitchen or bedroom.

We are so confident in the quality of our products that we offer a 5 year guarantee on all of our kitchen and bedroom fittings.

Don't just take our word for our quality - here are just a selection of the awards we have won for our product design excellence:

Award Winning Lighting























INNOVATION AWARDS
EXCEL LONDON 2011



ICONS EXPLAINED

All products have their own unique features. These icons will act as a guide.

 Chrome Finish	 Cool LED Colour	 Correlated Colour Temperature (CCT)	 Dimmable	 120°	 35,000 hrs
Finish colour	LED colour temperature	Correlated Colour Temperature (CCT)	Dimmable	Beam angle	LED life in hours
 2.5 metres	 2 per m	 Prismatic	 SLS	 Bluetooth	 On/off switch
Product cable length	No of LEDs per metre	Prismatic LED technology™	Surface Light Source - no visible LED points (™)	Bluetooth	On/off switch
 COB	 PIR sensor switch	 IR sensor switch	 R	 Rechargeable	 Battery operated (AA or AAA)
Chip on board LED technology	PIR sensor switch	IR sensor switch	Ideal for retro-fitting	Rechargeable lithium-ion battery	Battery operated (AA or AAA)
 iOS	 Registered Design Rights	 RGB	 3-in-1 colour TrioTone™ light	 IP	 Fire Rated
Sensio app controlled	Registered Design Rights	Colour changing	3-in-1 colour TrioTone™ light	Indicates protection against water	Fire Rated



TRIOTONE™



Warm white 3000K



Natural white 4000K



Cool white 5000K



Warm white 3000K

Natural white 4000K

Cool white 5000K



CORRELATED COLOUR TEMPERATURE (CCT)

CCT is a new concept that provides seamless transition from warm to cool white temperatures.

Our range of CCT products enables the user to cycle through the full spectrum of temperatures between cool and natural light, then from natural to warm light.

This allows the customer to mimic outside lighting conditions with much greater accuracy - a feature that has been scientifically proven to have a positive impact on our health.

CONTENTS

10 KITCHEN LIGHTING

12 UNDER CABINET SPOT LIGHTING

NEW

14 QUADRA PRO / QUADRA PRO IR

NEW

16 ALPHA-R / ALPHA-S

18 HYPE TRIOTONE

20 BERMUDA TRIOTONE

22 PAD2

24 ALTI

26 QUADRA MODERN

28 LARA 2

30 HYPE

32 ORBIT

34 NOVUS

36 BERMUDA

38 ORA

40 PINTO

42 GX53 CIRCA

44 GX53 TRIGON

46 UNDER CABINET STRIP LIGHTING

NEW

48 CONNEX SINGLE / CONNEX TRIOTONE

50 ARROW

52 ALBUS

54 IN CABINET LIGHTING

56 QUADRA MODERN

58 SHELF LIGHTING

NEW

60 EDGE PRO

NEW

62 TORINO

NEW

64 GENOA

66 DRAWER LIGHTING

NEW

68 DURA PLUS

70 VERSO

72 PLINTH LIGHTING

NEW

74 HALO TRIOTONE

76 LUCE

78 SPECTO

80 PURO

82 NIMBUS

84 FLEXIBLE STRIP LIGHTING

86 SIGMA

88 QUANTUM

90 COMPACT

92 VIVA 2

94 PRIMO 2

96 DUOFLEX

98 RGB 2

100 SENSIO MULTILIGHT APP

102 INTEGRATED SOLUTIONS & PROFILES

- NEW** 104 CONTOUR
- 106 MANTA
- 108 BEAM
- 110 LINIA
- 112 FINO

114 BATTERY LIGHTING

- 116 DOMA
- 118 OPAL

120 CEILING LIGHTING

- 122 ZIRCONIA
- 124 BELLATRIX
- NEW** 126 IP65 GU10 / TRIOTONE DOWNLIGHT

128 SENSIPODS

- 130 SENSIPOD
- 132 SENSIPOD+
- 134 SENSIPOD BLUETOOTH

136 BEDROOM LIGHTING

138 RECHARGEABLE BATTERY WARDROBE LIGHTING

- NEW** 140 MAGNUM
- 142 ALTO
- 144 SOLUS
- 146 MIMAS
- 148 PRISMA
- 150 ORION
- 152 INCLINE

154 LOW VOLTAGE WARDROBE LIGHTING

- 156 ELARA
- 158 OPERIO

160 LIGHTING CONTROL

- NEW** 162 3-IN-1 REMOTE
- NEW** 164 LINK-S
- NEW** 166 24V PIR SENSOR SWITCH
- 168 CANNON
- 170 MODA
- 172 250W INFRA-RED SENSOR SWITCH
- 174 IN-CABINET PIR SENSOR SWITCH
- 176 250W IN-CABINET SENSOR SWITCH

178 DRIVERS

- NEW** 179 DIMMABLE DRIVER

180 PRODUCT INDEX



KITCHEN LIGHTING



UNDER CABINET SPOT LIGHTING

- Perfectly positioned to ensure the kitchen becomes an easier working space for everyday tasks such as food preparation.
- Typically positioned under wall units to illuminate worktops.
- We recommend using 2-3 spot lights every metre. This creates a triangular lighting effect.



QUADRA PRO / QUADRA PRO IR

COLOUR TEMPERATURE CHANGEABLE UNDER CABINET LIGHT

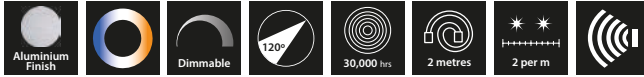

- LED technology for long service life
- Stylish and easy to install
- Ideal for under cabinet lighting
- High light output
- In built infra-red sensor for detection as well as colour changing function
- Fittings can be daisy chained for simple installation
- Can be used as an over cabinet light by purchasing mounting brackets



Quadra Pro IR Colour Temperature Changeable Under Cabinet Light (WITH SENSOR) - (2900-6000K)

CODE	Wattage	Voltage	Qty	Lumens	Driver	RRP
SE21092P0	2.5W	● 24V	1	165 lm	Required	£38.22
SE21292P3*	7.5W	● 24V	3	165 lm	15W included	£116.48

*Pack includes 1 x SE21092P0, 2 x SE21192P0, 1 x SE40555



Quadra Pro Colour Temperature Changeable Under Cabinet Light (WITHOUT SENSOR) - (2900-6000K)

CODE	Wattage	Voltage	Qty	Lumens	Driver	RRP
SE21192P0	2.5W	● 24V	1	165 lm	Required	£28.80
SE21392P3*	7.5W	● 24V	3	165 lm	15W included	£180.78

*Pack includes 3 x SE21192P0, 1 x SE40555, 1 x SE1004100, 1 x SE791990

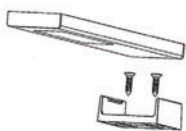

Over cabinet mounting (each bracket to be bought separately)

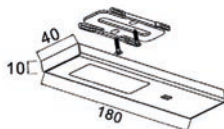

Under cabinet mounting (bracket provided with each fitting)

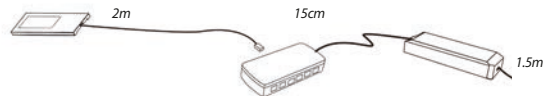

Image shows how this product is wired to a driver

Cables, Connectors and Accessories (optional)

CODE	DESCRIPTION	RRP
SE240920	Over cabinet mounting bracket	£1.46



Inset shows SE240920 Mounting Bracket (required to transform the Quadra into an over cabinet light)



Warm white 2900K

Natural white 4000K

Cool white 6000K

ALPHA-R / ALPHA-S UNDER CABINET SPOT LIGHT



- LED technology for long service life
- Stylish and easy to install
- Ideal for under cabinet lighting
- High light output
- Super slim design - 3mm thick
- Available in warm and cool white
- Two sizes available (square and rectangular)

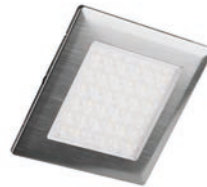

Alpha-R Under Cabinet Spot Light - **Cool White (5000K)**

CODE	Wattage	Voltage	Qty	Lumens	Driver	RRP
SE11390C0	3W	24V	1	330 lm	Required	£24.24
SE11390C3*	9W	24V	3	330 lm	15W included	£93.84

*Pack includes 3 x SE11390C0, 1 x SE40555

Alpha-S Under Cabinet Spot Light - **Cool White (5000K)**

CODE	Wattage	Voltage	Qty	Lumens	Driver	RRP
SE11490C0	3W	24V	1	330 lm	Required	£22.32
SE11490C3*	9W	24V	3	330 lm	15W included	£88.20

*Pack includes 3 x SE11490C0, 1 x SE40555

Alpha-R Under Cabinet Spot Light - **Warm White (3000K)**

CODE	Wattage	Voltage	Qty	Lumens	Driver	RRP
SE11390W0	3W	24V	1	250 lm	Required	£24.24
SE11390W3*	9W	24V	3	250 lm	15W included	£93.84

*Pack includes 3 x SE11390W0, 1 x SE40555

Alpha-S Under Cabinet Spot Light - **Warm White (3000K)**

CODE	Wattage	Voltage	Qty	Lumens	Driver	RRP
SE11490W0	3W	24V	1	250 lm	Required	£22.32
SE11490W3*	9W	24V	3	250 lm	15W included	£88.20

*Pack includes 3 x SE11490W0, 1 x SE40555

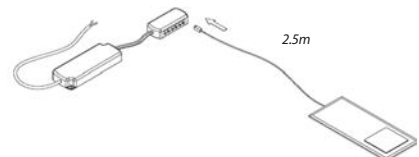
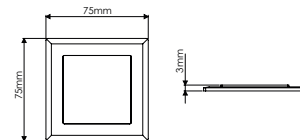
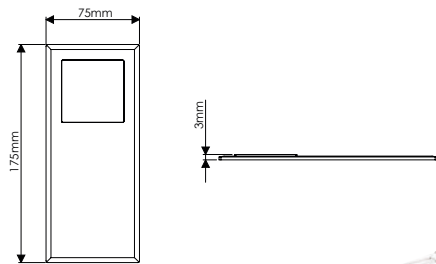

Cables, Connectors and Accessories

CODE	DESCRIPTION	RRP
SE9009	2.5m Extension Cable	£3.00

SE9009

Image shows how this product is wired to a driver



HARRIET NICHOLS
BISCUITS

HARRIET NICHOLS

HARRIET NICHOLS
COFFEE

277g

HYPE TRIOTONE™

LED SURFACE/RECESSED LIGHT



• **Registered Design Right - 6022106**

- 1 light - 3 colour temperatures
- Choose between cool white, natural white and warm white by flicking a switch on the back of the fitting
- Simple to use and easy to install. Choose the colour temperature that suits your kitchen
- Cable can be unplugged from the back of the fitting via quick-release connector
- Fitting supplied with collar for surface mounting
- Sleek appearance
- Diffused light - no visible dots
- Luminous efficacy of 79-91 lm/W



Hype TrioTone LED Surface/Recessed Light - (3000K, 4000K, 5000K)

CODE	Wattage	Voltage	Qty	Lumens	Driver	RRP
SE21100	1.65W	● 24V	1	130-150 lm	Required	£20.76
SE21100K2	3.3W	● 24V	2	130-150 lm	6W included	£57.74
SE21100K3	4.95W	● 24V	3	130-150 lm	6W included	£78.08

Change switch



Quick-release connector

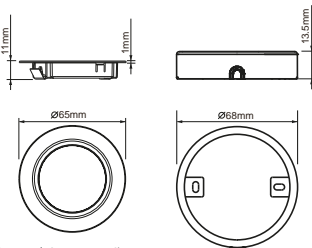

Recessed: Cut out size: Ø60mm



Image shows how this product is wired to a driver

Cables, Connectors and Accessories

CODE	DESCRIPTION	RRP
SE9009	2.5m Extension Cable	£3.00



SE9009



Warm white 3000K



Natural white 4000K



Cool white 5000K

BERMUDA TRIOTONE™

LED TRIANGLE LIGHT



• **Registered Design Right - 6022106**

- 1 light - 3 colour temperatures
- Choose between cool white, natural white and warm white by flicking a switch on the back of the fitting
- Simple to use and easy to install. Choose the colour temperature that suits your kitchen
- Cable can be unplugged from the back of the fitting via quick-release connector
- Fitting supplied with collar for surface mounting
- Sleek appearance
- Diffused light - no visible dots
- Luminous efficacy of 79-91 lm/W

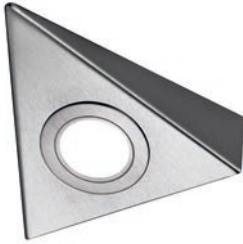

Bermuda TrioTone LED Triangle Light - (3000K, 4000K, 5000K)



Change switch

CODE	Wattage	Voltage	Qty	Lumens	Driver	RRP
SE21000	1.65W	● 24V	1	130-150 lm	Required	£22.44
SE21000K2	3.3W	● 24V	2	130-150 lm	6W included	£61.03
SE21000K3	4.95W	● 24V	3	130-150 lm	6W included	£83.03

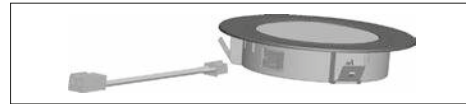

Quick-release connector

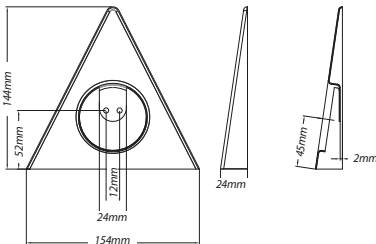

Cables, Connectors and Accessories

CODE	DESCRIPTION	RRP
SE9009	2.5m Extension Cable	£3.00

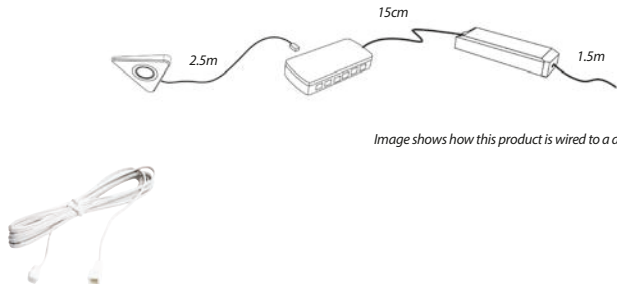

Image shows how this product is wired to a driver

SE9009



Warm white 3000K



Natural white 4000K



Cool white 5000K

PAD2

PRISMATIC™ LED LIGHT



- Featuring **PRISMATIC** LED technology
- Contains an innovative diffuser with an etched design to completely diffuse light
- Discreet 7mm depth
- Elongated light panel to allow for an increased spread of light across the worktop
- No visible diodes reflect on the worktop
- Superb bright light output
- Maximum luminous efficacy of 88 lm/W
- Switch/dim using Sensio sensors and controllers



PAD2 Prismatic LED Light - **Cool White (5000K)**

CODE	Wattage	Voltage	Qty	Lumens	Driver	RRP
SE22006C0	3.5W	● 24V	1	308 lm	Required	£39.60
SE22006C2	7W	● 24V	2	308 lm	15W included	£100.20
SE22006C3	10.5W	● 24V	3	308 lm	15W included	£139.01

PAD2 Prismatic LED Light - **Warm White (3000K)**

CODE	Wattage	Voltage	Qty	Lumens	Driver	RRP
SE22006W0	3.5W	● 24V	1	301 lm	Required	£39.60
SE22006W2	7W	● 24V	2	301 lm	15W included	£100.20
SE22006W3	10.5W	● 24V	3	301 lm	15W included	£139.01

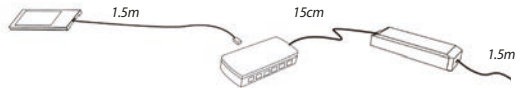
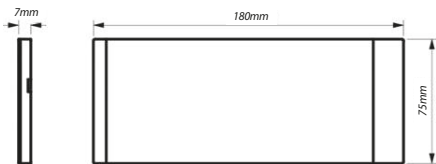

Image shows how this product is wired to a driver

Cables, Connectors and Accessories

CODE	DESCRIPTION	RRP
SE9009	2.5m Extension Cable	£3.00



SE9009



ALTI

SQUARE PRISMATIC™ LED LIGHT



- Featuring **PRISMATIC** LED technology
- Contains an innovative diffuser with an etched design to completely diffuse light
- Super thin depth of 7mm
- Due to super slim design the Alti is great for kitchens without a pelmet
- No visible diodes
- Superbly bright output
- Maximum luminous efficacy of 91lm/W
- Switch/dim using Sensio sensors and controllers



ALTI Square Prismatic LED Light - **Cool White (5000K)**

CODE	Wattage	Voltage	Qty	Lumens	Driver	RRP
SE21006C0	3.5W	● 24V	1	319 lm	Required	£21.12
SE21006C2	7W	● 24V	2	319 lm	15W included	£63.97
SE21006C3	10.5W	● 24V	3	319 lm	15W included	£84.67

ALTI Square Prismatic LED Light - **Warm White (3000K)**

CODE	Wattage	Voltage	Qty	Lumens	Driver	RRP
SE21006W0	3.5W	● 24V	1	291 lm	Required	£21.12
SE21006W2	7W	● 24V	2	291 lm	15W included	£63.97
SE21006W3	10.5W	● 24V	3	291 lm	15W included	£84.67

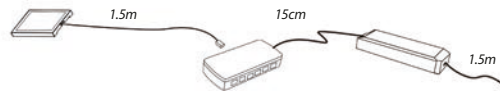
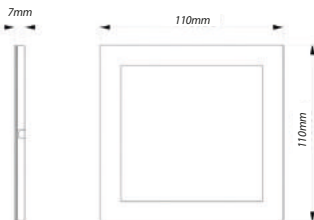

Image shows how this product is wired to a driver

Cables, Connectors and Accessories

CODE	DESCRIPTION	RRP
SE9009	2.5m Extension Cable	£3.00



SE9009



QUADRA MODERN

LED UNDER CABINET LIGHT



• **Registered Design Right - 6024086**

- Multi-functional design, unique to Sensio in the UK
- Elongated design allows for vast spread of light across worktop
- Specialised lens diffuses LEDs to create the appearance of invisible diodes
- High number of LEDs for bright light output
- Easy installation using daisy chaining to fit multiple lights into one area
- Specially designed mounting brackets allow for simple installation
- Can be used as an over cabinet light by purchasing mounting brackets



Quadra Modern LED Under Cabinet Light - **Cool White (5600K)**

CODE	Wattage	Voltage	Qty	Lumens	Driver	RRP
SE21092C0	2.5W	● 24V	1	170 lm	Required	£21.12
SE21092C2	5W	● 24V	2	170 lm	6W included	£58.45
SE21092C3	7.5W	● 24V	3	170 lm	15W included	£84.67

Quadra Modern LED Under Cabinet Light - **Warm White (3000K)**

CODE	Wattage	Voltage	Qty	Lumens	Driver	RRP
SE21092W0	2.5W	● 24V	1	155 lm	Required	£21.12
SE21092W2	5W	● 24V	2	155 lm	6W included	£58.45
SE21092W3	7.5W	● 24V	3	155 lm	15W included	£84.67

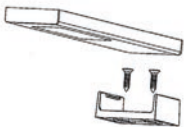

Over cabinet mounting (each bracket to be bought separately)

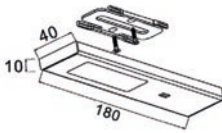

Under cabinet mounting (bracket provided with each fitting)



Image shows how this product is wired to a driver

Cables, Connectors and Accessories (optional)

CODE	DESCRIPTION	RRP
SE240920	Over cabinet mounting bracket	£1.46
SE9009	2.5m Extension Cable	£3.00



SE9009



Inset shows SE240920 Mounting Bracket (required to transform the Quadra into an over cabinet light)



LARA 2

SURFACE/RECESSED LIGHT



- High quality, high output. Double the brightness of the standard Hype surface light
- No visible LED points
- Sleek and bright
- Perfect for task lighting or to illuminate cabinet interiors in glass fronted wall units
- Spacer included
- Can be surface mounted or recessed
- Luminous efficacy of 73 lm/W
- Aluminium fitting has great thermal conduction



Lara 2 Surface/Recessed Light - **Cool White (5000K)**

CODE	Wattage	Voltage	Qty	Lumens	Driver	RRP
SE21202C0	3W	● 24V	1	220 lm	Required	£21.42
SE21202C2	6W	● 24V	2	220 lm	6W included	£59.04
SE21202C3	9W	● 24V	3	220 lm	15W included	£85.56

Lara 2 Surface/Recessed Light - **Warm White (3000K)**

CODE	Wattage	Voltage	Qty	Lumens	Driver	RRP
SE21202W0	3W	● 24V	1	200 lm	Required	£21.42
SE21202W2	6W	● 24V	2	200 lm	6W included	£59.04
SE21202W3	9W	● 24V	3	200 lm	15W included	£85.56



Recessed: Cut out size: Ø59-60mm

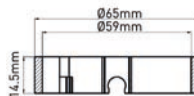
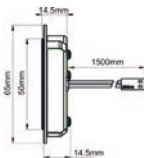

Surface mounted

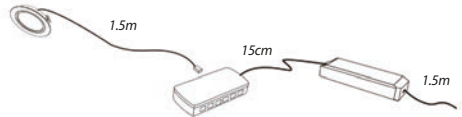

Image shows how this product is wired to a driver

Cables, Connectors and Accessories

CODE	DESCRIPTION	RRP
SE9009	2.5m Extension Cable	£3.00



SE9009



HYPE

LED SURFACE/RECESSED LIGHT



- Frosted cover for diffused LEDs
- Fitting supplied with collar for surface mounting
- Stainless steel fitting great for both contemporary and traditional kitchens
- Luminous efficacy of 80 lm/W
- Use as task lighting or illuminate cabinet interiors with glass fronted wall units
- Over 90% less energy use than halogen
- Can be used with a range of Sensio switches and dimmers



Hype LED Surface Light - **Cool White (6500K)**

CODE	Wattage	Voltage	Qty	Lumens	Driver	RRP
SE90050C0	1.65W	● 24V	1	100 lm	Required	£15.36
SE90050C2	3.3W	● 24V	2	100 lm	6W included	£47.16
SE90050C3	4.95W	● 24V	3	100 lm	6W included	£62.21



Hype LED Surface Light - **Warm White (3000K)**

CODE	Wattage	Voltage	Qty	Lumens	Driver	RRP
SE90050W0	1.65W	● 24V	1	93 lm	Required	£15.36
SE90050W2	3.3W	● 24V	2	93 lm	6W included	£47.16
SE90050W3	4.95W	● 24V	3	93 lm	6W included	£62.21

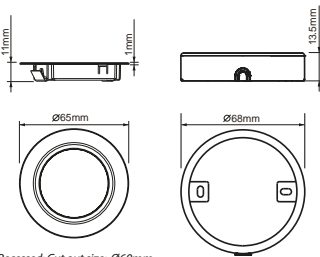

Recessed: Cut out size: Ø60mm

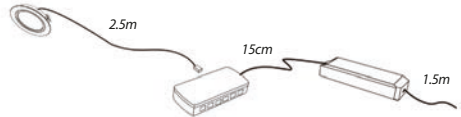

Image shows how this product is wired to a driver

Cables, Connectors and Accessories

CODE	DESCRIPTION	RRP
SE9009	2.5m Extension Cable	£3.00



SE9009



ORBIT

TILTABLE LED LIGHT



- Tiltable, super bright LED spot light
- Tiltable centre section allows light to be directed to any desired position
- Fitting supplied with collar
- Luminous efficacy of 59/81 lm/W
- High performance LED chips for optimum light output
- Use as task lighting or illuminate cabinet interiors with glass fronted wall units
- Long lamp life - lasts up to 47,500 hours more than halogen
- Can be used with a range of Sensio switches and dimmers
- Die cast metal exterior



Orbit Tiltable LED Light - **Cool White (5000K)**

CODE	Wattage	Voltage	Qty	Lumens	Driver	RRP
SE9008HDCW	3W	● 12V	1	243 lm	Required	£30.96
SE9008HDCWK2	6W	● 12V	2	243 lm	6W included	£77.75
SE9008HDCWK3	9W	● 12V	3	243 lm	15W included	£113.60

Orbit Tiltable LED Light - **Warm White (3000K)**

CODE	Wattage	Voltage	Qty	Lumens	Driver	RRP
SE9008HDWW	3W	● 12V	1	176 lm	Required	£30.96
SE9008HDWWK2	6W	● 12V	2	176 lm	6W included	£77.75
SE9008HDWWK3	9W	● 12V	3	176 lm	15W included	£113.60

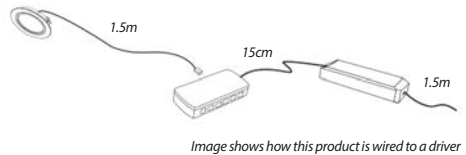
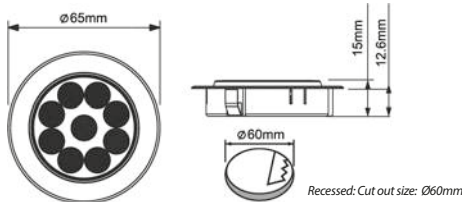

Cables, Connectors and Accessories

CODE	DESCRIPTION	RRP
SE9009	2.5m Extension Cable	£3.00



SE9009

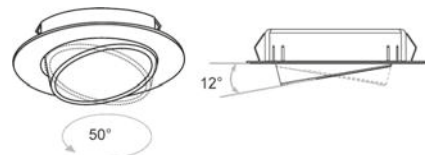



NOVUS

HD LED TRIANGLE LIGHT



- Slim profile design of the popular triangle light
- Perfect for kitchens without a pelmet
- Luminous efficacy of 80 lm/W
- High definition LEDs
- Lens over each diode to intensify light output
- Long lamp life - lasts up to 47,500 hours more than halogen
- 24 integrated LEDs
- Can be used with a range of Sensio switches and dimmers
- Supplied with detachable cable 75mm from the base of the fitting



Novus HD LED Triangle Light - **Cool White (5000K)**

CODE	Wattage	Voltage	Qty	Lumens	Driver	RRP
SE9001HDCW	1.65W	● 24V	1	132 lm	Required	£23.44
SE9001HDCW2	3.3W	● 24V	2	132 lm	6W included	£62.99
SE9001HDCW3	4.95W	● 24V	3	132 lm	6W included	£85.96



Novus HD LED Triangle Light - **Warm White (3000K)**

CODE	Wattage	Voltage	Qty	Lumens	Driver	RRP
SE9001HDWW	1.65W	● 24V	1	123 lm	Required	£23.44
SE9001HDWW2	3.3W	● 24V	2	123 lm	6W included	£62.99
SE9001HDWW3	4.95W	● 24V	3	123 lm	6W included	£85.96

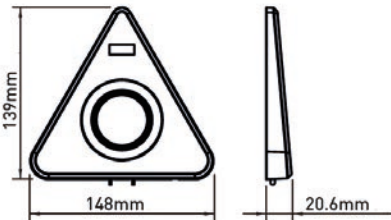

Image shows how this product is wired to a driver

Cables, Connectors and Accessories

CODE	DESCRIPTION	RRP
SE9009	2.5m Extension Cable	£3.00



SE9009



BERMUDA

LED TRIANGLE LIGHT



- Traditional look, modern solution
- Stainless steel fitting great for both contemporary and traditional kitchens
- Luminous efficacy of 80 lm/W
- Long lamp life - lasts up to 32,500 hours more than halogen
- Can be used with a range of Sensio switches and dimmers



Bermuda HD LED Triangle Light - **Cool White (6500K)**

CODE	Wattage	Voltage	Qty	Lumens	Driver	RRP
SE90010C0	1.65W	● 24V	1	100 lm	Required	£15.36
SE90010C2	3.3W	● 24V	2	100 lm	6W included	£47.16
SE90010C3	4.95W	● 24V	3	100 lm	6W included	£62.21



Bermuda HD LED Triangle Light - **Warm White (3000K)**

CODE	Wattage	Voltage	Qty	Lumens	Driver	RRP
SE90010W0	1.65W	● 24V	1	93 lm	Required	£15.36
SE90010W2	3.3W	● 24V	2	93 lm	6W included	£47.16
SE90010W3	4.95W	● 24V	3	93 lm	6W included	£62.21

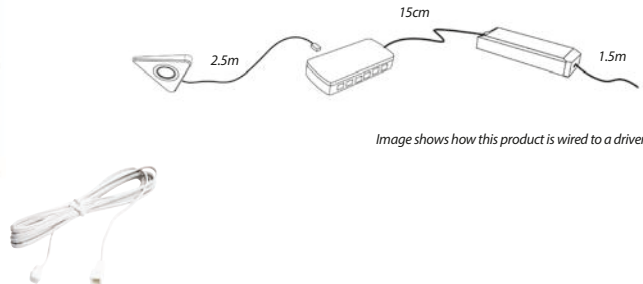
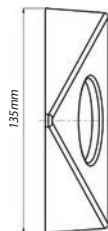
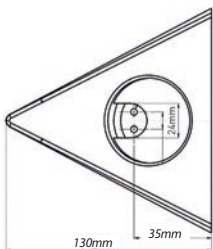

Image shows how this product is wired to a driver

Cables, Connectors and Accessories

CODE	DESCRIPTION	RRP
SE9009	2.5m Extension Cable	£3.00

SE9009



ORA

HD LED SQUARE SURFACE LIGHT



- Perfect for the minimalist kitchen design
- Stainless steel fitting great for both contemporary and traditional kitchens
- Fitting has a depth of only 8.8mm
- Luminous efficacy of 75 lm/W
- Use as task lighting or illuminate cabinet interiors with glass fronted wall units
- 18 high definition integrated LEDs
- Lens over each diode to intensify light output
- Can be used with a range of Sensio switches and dimmers



Ora HD LED Square Surface Light - **Cool White (5000K)**

CODE	Wattage	Voltage	Qty	Lumens	Driver	RRP
SE9007HDCW	1.8W	● 24V	1	135 lm	Required	£20.52
SE9007HDCWK2	3.6W	● 24V	2	135 lm	6W included	£57.28
SE9007HDCWK3	5.4W	● 24V	3	135 lm	6W included	£77.39

Ora HD LED Square Surface Light - **Warm White (3000K)**

CODE	Wattage	Voltage	Qty	Lumens	Driver	RRP
SE9007HDWW	1.8W	● 24V	1	128 lm	Required	£20.52
SE9007HDWWK2	3.6W	● 24V	2	128 lm	6W included	£57.28
SE9007HDWWK3	5.4W	● 24V	3	128 lm	6W included	£77.39

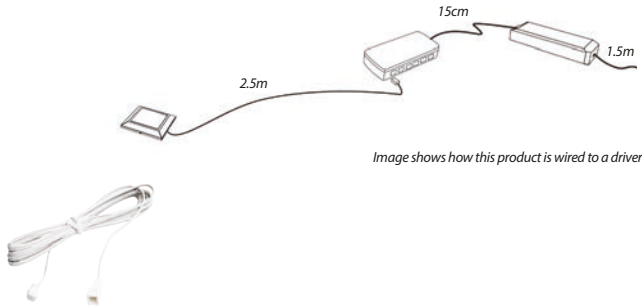
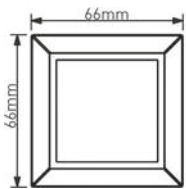

Image shows how this product is wired to a driver

Cables, Connectors and Accessories

CODE	DESCRIPTION	RRP
SE9009	2.5m Extension Cable	£3.00

SE9009



HARVEY NICHOLS
BISCUITS

HARVEY NICHOLS

HARVEY NICHOLS
COFFEE
227g

PINTO

LED FLAT DISC LIGHT



- Sleek, bright and discreet
- Fitting is only 6mm deep
- Can be used under kitchen cabinets as a task light or inside glass fronted wall units as mood lighting
- 16 integrated LEDs
- Each fitting runs at only 1.5W so 4 fittings can be run from a single 6W driver
- Simple to install, surface mount using 2 screws



Pinto LED Flat Disc Light - **Cool White (5000K)**

CODE	Wattage	Voltage	Qty	Lumens	Driver	RRP
SE10138CW24	1.5W	● 24V	1	120 lm	Required	£6.60
SE10138CW3.24	4.5W	● 24V	3	120 lm	6W included	£36.46



Pinto LED Flat Disc Light - **Warm White (3000K)**

CODE	Wattage	Voltage	Qty	Lumens	Driver	RRP
SE10138WW24	1.5W	● 24V	1	112 lm	Required	£6.60
SE10138WW3.24	4.5W	● 24V	3	112 lm	6W included	£36.46

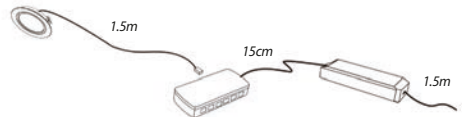
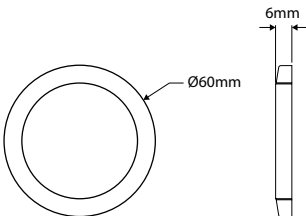

Image shows how this product is wired to a driver



GX53 CIRCA

LED SURFACE/RECESSED LIGHT



- Mains LED Spot lighting - anyone can install when using the distribution block accessory
- Stainless steel fitting
- Choose from two high output, energy efficient GX53 LED lamps
- No driver required
- Extremely simple connection system
- Mains cable has connector attached which plugs into the SE11175
- Distribution unit has pre-wired 13A plug
- 50 integrated diodes for optimum light output
- Lamps are simple to replace using twist and lock mechanism

Step 1 - Choose your light fitting:

GX53 Circa LED Recessed/Surface Light

CODE	Voltage	Qty	RRP
SE11146SS	240V	1	£14.04



Step 2 - Choose your lamp:

Cool White (5800K)

CODE	Wattage	Voltage	LED Qty	Lumens	Qty	RRP
SE10156CW	3W	240V	50	250 lm	1	£21.12



Warm White (3000K)

CODE	Wattage	Voltage	LED Qty	Lumens	Qty	RRP
SE10156WW	3W	240V	50	245 lm	1	£24.96

Surface Mounted

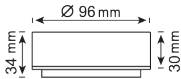

Recessed

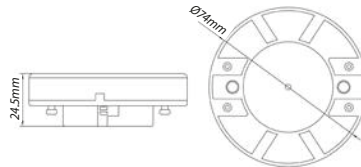
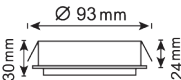

Cables, Connectors and Accessories

CODE	DESCRIPTION	RRP
SE11175	GX53 6 Way Distributor Block with 1.5m Cable & Plug	£12.48



SE11175



GX53 TRIGON LED TRIANGLE LIGHT



- Mains LED Spot lighting - anyone can install when using the distribution block accessory
- Stainless steel triangle light fitting only
- Buy the fitting and then choose LED lamp from table below
- No driver is required
- Extremely simple connection system
- Mains cable has connector attached which plugs into the SE11175
- 50 diodes integrated for optimum light output
- Angled aspect directs light forward onto worktop
- Lamps are simple to replace using twist and lock mechanism

Step 1 - Choose your light fitting:

GX53 Trigon LED Triangle Light

CODE	Voltage	Qty	RRP
SE11147SS	240V	1	£12.72

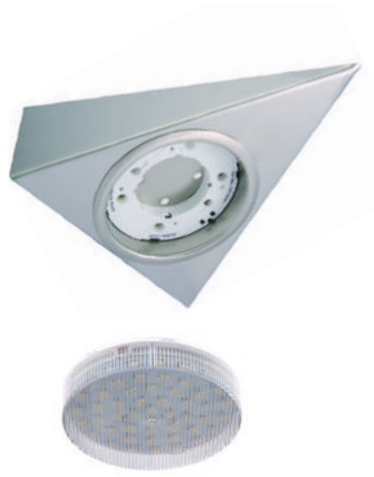

Step 2 - Choose your lamp:

Cool White (5800K)

CODE	Wattage	Voltage	LED Qty	Lumens	Qty	RRP
SE10156CW	3W	240V	50	250 lm	1	£21.12

Warm White (3000K)

CODE	Wattage	Voltage	LED Qty	Lumens	Qty	RRP
SE10156WW	3W	240V	50	245 lm	1	£24.96

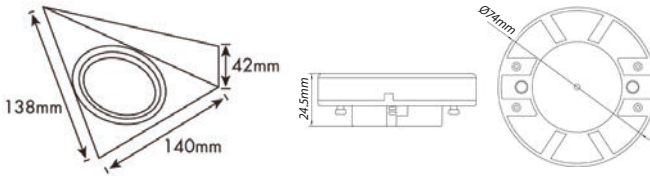

Cables, Connectors and Accessories

CODE	DESCRIPTION	RRP
SE11175	GX53 6 Way Distributor Block with 1.5m Cable & Plug	£12.48



SE11175





UNDER CABINET STRIP LIGHTING

- The ultimate task lighting solution.
- Create a continuous run of unbroken light by using an LED strip light.



CONNEX SINGLE COLOUR CONNEX TRIOTONE™ 240V LED STRIP LIGHT



- Improved spec
- No visible LEDs
- Extremely high light output for effective task lighting
- Integrated LED driver for simple installation
- Energy efficient
- Can be interlinked
- Supplied with 1.5m of bare ended mains cable for simple installation
- No driver required
- Available as warm white or TrioTone™



Connex Single 240V LED Strip Light - Warm White (3000K)

CODE	Wattage	Voltage	Length	Qty	Lumens	RRP
SE100190	3W	240V	222mm	1	300 lm	£9.85
SE100290	5W	240V	343mm	1	500 lm	£11.78
SE100790	8W	240V	524mm	1	800 lm	£12.96
SE100990	16W	240V	904mm	1	1600 lm	£17.94

Connex TrioTone™ 240V LED Strip Light - (3000K, 4000K, 5000K)

CODE	Wattage	Voltage	Length	Qty	Lumens	RRP
SE100390	3W	240V	222mm	1	240-260 lm	£18.18
SE100490	5W	240V	343mm	1	400-430 lm	£20.76
SE100590	9W	240V	524mm	1	765-810 lm	£24.35
SE100690	12W	240V	623mm	1	980-1080 lm	£25.63

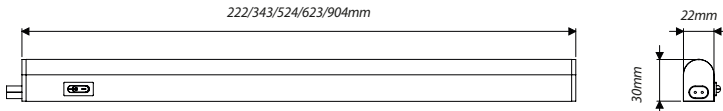

Cables, Connectors and Accessories

CODE	DESCRIPTION	RRP
SE101290	Connex Joining Cable - 500mm	£2.15
SE101190	Connex Joining Cable - 250mm	£1.70



SE101290



SE101190



ARROW

SLIM PROFILE LED STRIP LIGHT



- Continuous, diffused LED Under Cabinet Lighting
- Contains unique configuration of diffusers to evenly distribute light
- No visible LED points
- Available in 4 lengths, tailored to perfectly fit all cabinet sizes and combinations
- Can be interlinked with no visible joins
- Slim profile of only 13mm
- High lumen output and wide beam angle
- Maximum length of 3600mm when interlinked
- End cap measures 20mm
- Starter cable to be purchased separately



Arrow Slim Profile LED Strip Light - **Cool White (5000K)**

CODE	Wattage	Voltage	Length	Qty	Lumens	Driver	RRP
SE9071HDCW	2.5W	● 24V	200mm	1	295 lm	Required	£21.78
SE9074HDCW	4W	● 24V	300mm	1	472 lm	Required	£28.44
SE9075HDCW	7.5W	● 24V	570mm	1	958 lm	Required	£54.36
SE9076HDCW	11.5W	● 24V	870mm	1	1387 lm	Required	£84.96

Arrow Slim Profile LED Strip Light - **Warm White (3000K)**

CODE	Wattage	Voltage	Length	Qty	Lumens	Driver	RRP
SE9071HDWW	2.5W	● 24V	200mm	1	258 lm	Required	£21.78
SE9074HDWW	4W	● 24V	300mm	1	413 lm	Required	£28.44
SE9075HDWW	7.5W	● 24V	570mm	1	838 lm	Required	£54.36
SE9076HDWW	11.5W	● 24V	870mm	1	1213 lm	Required	£84.96

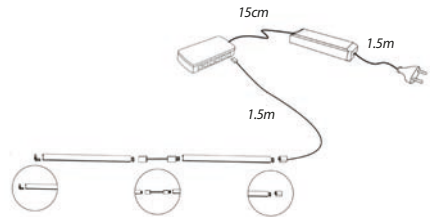
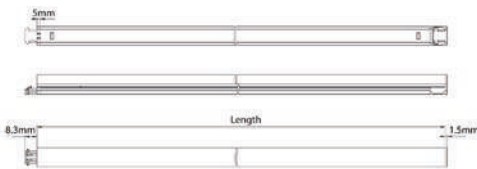

Image shows how this product is wired to a driver

Cables, Connectors and Accessories

CODE	DESCRIPTION	RRP
SE9078HD*	1.5m Arrow Starter Cable * Required to run the Arrow (at least one required per run)	£4.56
SE9077HD	50mm Arrow Corner Connector	£3.00
SE9079HD	500mm Joining Cable	£3.48



SE9078HD



SE9077HD



SE9079HD



ALBUS

LED STRIP LIGHT



- Ultimate ease of installation
- Fittings can be interlinked
- No driver required
- High number of LEDs for maximum light output
- Angled fitting for optimum illumination of worktops
- Supplied with 1m of mains cable for simple installation



Albus LED Strip Light - Cool White (6000K)

CODE	Wattage	Voltage	Length	Qty	Lumens	RRP
SE12250-250mm	2.7W	240V	250mm	1	235 lm	£38.40
SE12330-330mm	3.6W	240V	330mm	1	325 lm	£43.92
SE12550-550mm	6.8W	240V	550mm	1	605 lm	£63.00

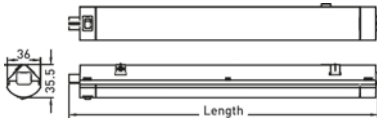

Cables, Connectors and Accessories

CODE	DESCRIPTION	RRP
SE12005	500mm Link Cable	£3.12





IN CABINET LIGHTING

- A beautiful added extra bringing luxury to any kitchen design.
- For Retro-Fit Rechargeable Battery/Low Voltage In-Cabinet Lighting see pages 138 - 149.



QUADRA MODERN

LED IN CABINET LIGHT



• **Registered Design Right - 6024086**

- Multi-functional design, unique to Sensio in the UK
- Specialised lens diffuses LEDs to create the appearance of invisible diodes
- Integrated IR Sensor
- Light coloured doors - can be fitted 50mm from door
- Dark coloured doors - can be fitted 25mm from door
- High number of LEDs for bright light output
- Light switches on as door opens and off as door closes
- Easy installation using mounting bracket



Quadra Modern LED In Cabinet Light - **Cool White (5600K)**

CODE	Wattage	Voltage	Qty	Lumens	Driver	RRP
SE23092C0	2.5W	● 24V	1	170 lm	Required	£31.20



Quadra Modern LED In Cabinet Light - **Warm White (3000K)**

CODE	Wattage	Voltage	Qty	Lumens	Driver	RRP
SE23092W0	2.5W	● 24V	1	155 lm	Required	£31.20

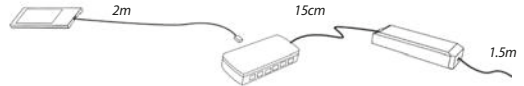
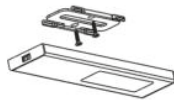
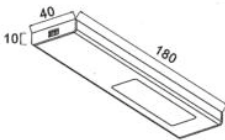

Image shows how this product is wired to a driver

Cables, Connectors and Accessories

CODE	DESCRIPTION	RRP
SE9009	2.5m Extension Cable	£3.00



SE9009



SHELF LIGHTING



- A stunning added extra to your lighting scheme, Shelf Lighting has a big impact.



EDGE PRO

COLOUR TEMPERATURE CHANGEABLE LED GLASS CLIP LIGHT



- Improved specification
- Glass shelves are a feature. Can be used to accentuate crockery or other kitchenware items
- Fits 4-8mm pane of glass
- Provides soft, ambient mood lighting
- White, diffused finish
- Light shines out towards front edge of the glass
- Can be cut to length
- Cut marks every 84mm
- Integrated diffuser provides no visible dots
- Extremely low wattage
- Use two lengths together for longer units
- Simple to install
- Edge Pro can be dimmer when used with a DuoFlex receiver and 3-in-1 remote



Inset shows the integrated diffuser on the EDGE PRO LED Glass Clip Light.

Edge Pro LED Glass Clip Light - (2700K - 6500K)

CODE	Wattage	Voltage	Length	Qty	Lumens	Driver	RRP
SE97095P	2W	• 24V	450mm	1	200 lm	Required	£24.00

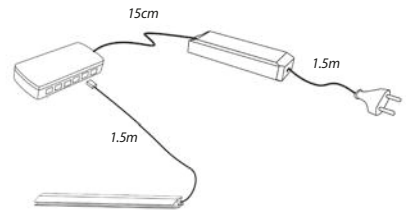

Image shows how this product is wired to a driver

Cables, Connectors and Accessories

CODE	DESCRIPTION	RRP
SE9009	2.5m Extension Cable	£3.00



SE9009



Warm white 2700K



Natural white 4000K



Cool white 6500K

TORINO

LED WALL MOUNTED SHELF



- LED technology for long service life
- Stylish and easy to install
- Contemporary design, provides a feature item for contemporary kitchen designs
- Available in two different lengths (600mm and 900mm)
- Available in back and silver finishes
- Compatible with Sensio LED drivers
- Aluminum frame and tempered glass shelf
- Load bearing capacity of up to 10kg



Torino LED Wall Mounted Shelf - **Natural White (4500K)**

CODE	Colour	Length	Wattage	Voltage	Qty	Lumens	Driver	RRP
SE17232CO	Silver	600mm	5.4W	● 24V	1	325 lm	Required	£94.50
SE17262CO	Silver	900mm	8.4W	● 24V	1	482 lm	Required	£114.00
SE17238CO	Black	600mm	5.4W	● 24V	1	325 lm	Required	£94.50
SE17268CO	Black	900mm	8.4W	● 24V	1	482 lm	Required	£114.00

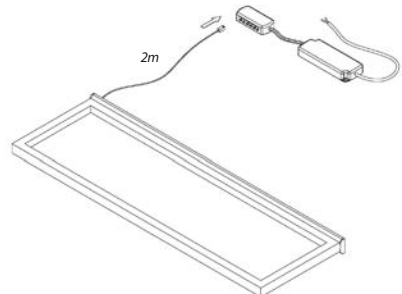
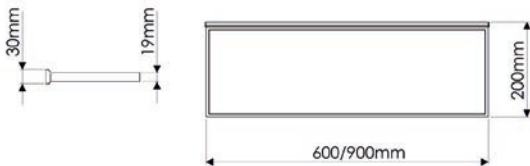

Image shows how this product is wired to a driver



GENOA

INTEGRATED LED SHELF PROFILE



- LED technology for long service life
- Stylish and easy to install
- Unique up and down shelf Light
- Integrated LED profile
- Available in two different lengths
- Suitable for 18mm wooden shelves
- Integrated diffuser
- Contemporary champagne finish contrasts excellently with most contemporary kitchen finishes

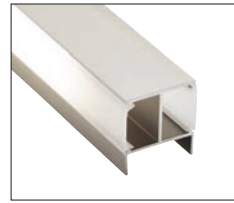

Inset shows the integrated diffuser on the GENOA LED Light.

Torino LED Wall Mounted Shelf - **Natural White (4500K)**

CODE	Wattage	Length	Wattage	Qty	Lumens	Driver	RRP
SE18492C0	7.7W	463mm	● 24V	1	413 lm	Required	£28.06
SE18592C0	9.5W	563mm	● 24V	1	475 lm	Required	£32.28

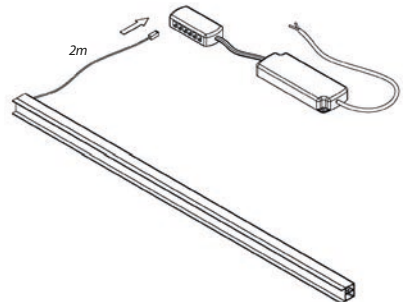
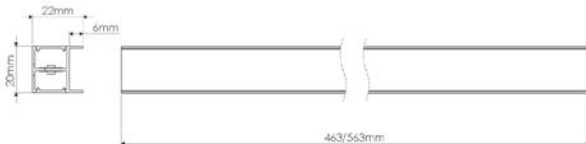

Image shows how this product is wired to a driver





DRAWER LIGHTING

- A functional convenience light which should be added to a design for ultimate ease of use.
- High definition LED drawer lights are a great added extra to illuminate dark drawers where additional light is often sought.



DURA PLUS

LED BATTERY LIGHT WITH PIR SENSOR



- Super bright and easy to install
- No wiring necessary - magnetic strip with 3M adhesive backing simply applies to inside of drawer
- Powered by 4 x AAA batteries (not included)
- Versatile product - can be used in various locations such as in drawers and in/under cabinets
- Integrated PIR sensor located in centre of fitting
- 20 or 60 second delay on sensor if no motion is detected
- Batteries have an approximate lifespan of 8 months when used for 3 minutes per day
- Dual mode functioning switch on the back of fixture
- Press functioning switch once to switch between modes

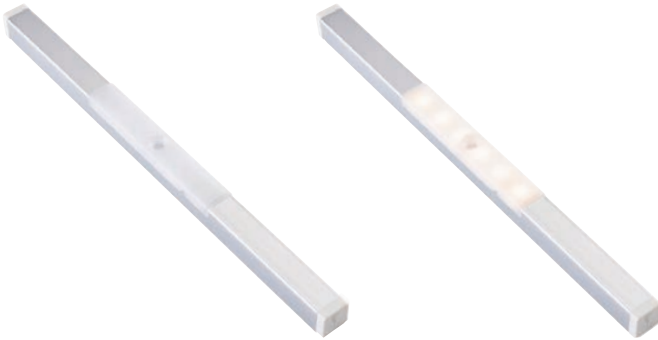

Dura Plus LED Battery Light With PIR Sensor - **Cool White (5000K)**

CODE	Power Supply	Qty	Lumens	RRP
SE16097C0	4 x AAA batteries*	1	40 lm	£20.40

* Batteries not included

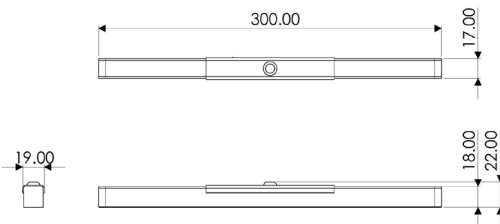



VERSO

LED DRAWER LIGHT



- Improved specification
- The ultimate functional light
- Various lengths available to suit standard drawer sizes
- High definition LED for optimum light output
- Integrated IR sensor on front edge - light will turn on when drawer is opened
- Energy saving. When drawer is closed, light turns off
- Low wattage - a full drawer pack can be powered from a single driver
- Brackets and cable tidy supplied to ensure no loose, unsightly wires
- Verso is suitable for use in both the kitchen and bedroom



Verso LED Drawer Light - **Natural White (4500K)**

CODE	Wattage	Voltage	Length	Qty	Lumens	Driver	RRP
SE7300HDCW24	2.6W	● 24V	462mm	1	225 lm	Required	£40.80
SE7305HDCW24	3.3W	● 24V	562mm	1	338 lm	Required	£43.38
SE7310HDCW24	4.5W	● 24V	762mm	1	420 lm	Required	£48.48
SE7315HDCW24	5.4W	● 24V	862mm	1	460 lm	Required	£51.96
SE7320HDCW24	6W	● 24V	962mm	1	500 lm	Required	£56.14
SE7325HDCW24	7.3W	● 24V	1162mm	1	590 lm	Required	£60.35

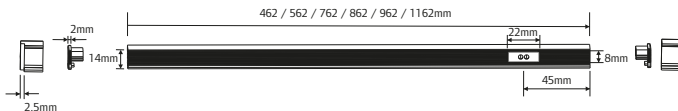

Cables, Connectors and Accessories

CODE	DESCRIPTION	RRP
SE9009	2.5m Extension Cable	£3.00



SE9009



PLINTH LIGHTING



- Integrate plinth lighting into your kitchen design to add dimension and depth to the room.
- Soft and gentle designs that tend to be, used for decorative purposes.
- Often an overlooked aspect of Kitchen Lighting but can have a huge impact.



HALO TRIOTONE™

COLOUR TEMPERATURE SWITCHABLE PLINTH LIGHT



- LED technology for long service life
- Stylish and easy to install
- Ideal for use on kitchen plinth boards
- Switch colour temperature to preferred setting (warm, natural or cool)
- High light output
- Fittings can be daisy chained for simple installation
- Available individually or as a pack of 4 or 8
- Diffused cover, no visible LEDs



Inset shows switch at back of fitting for colour change

Halo TrioTone™ Colour Temperature Switchable Plinth Light - (3000K, 4000K, 5000K)

CODE	Wattage	Voltage	Qty	Lumens	Driver	RRP
SE150000	0.5W	● 24V	1	28 lm	Required	£10.74
SE150004	2W	● 24V	4	28 lm	6W included	£58.80
SE150008	4W	● 24V	8	28 lm	6W included	£100.80

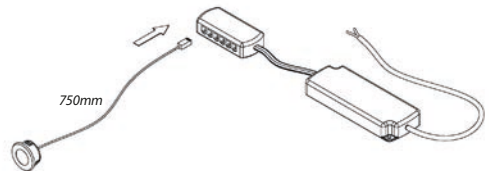
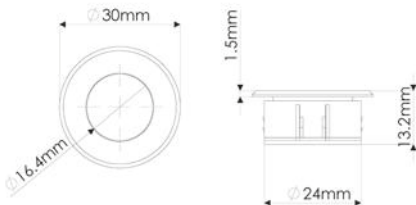

Image shows how this product is wired to a driver



Warm white 3000K

Natural white 4000K

Cool white 5000K

LUCE

LED SQUARE PLINTH LIGHT



- Super thin with invisible LEDs
- Stainless steel surround
- 6 diffused integrated LEDs
- No visible LED points
- Available individually or as a pack of 4 or 8
- Light sits flush to plinth
- Fittings can be daisy chained together
- Can be used with a range of Sensio switches and dimmers

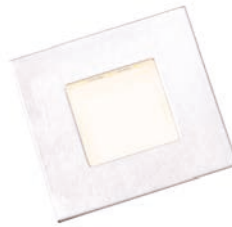
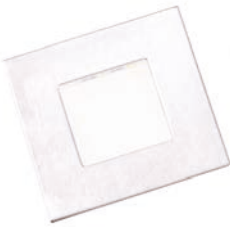

Luce LED Square Plinth Light - **Cool White (4000K)**

CODE	Wattage	Voltage	Qty	Lumens	Driver	RRP
SE15090C0	0.6W	● 24V	1	16 lm	Required	£6.55
SE15090C4	2.4W	● 24V	4	16 lm	6W included	£42.74
SE15090C8	4.8W	● 24V	8	16 lm	6W included	£68.42

Luce LED Square Plinth Light - **Warm White (3000K)**

CODE	Wattage	Voltage	Qty	Lumens	Driver	RRP
SE15090W0	0.6W	● 24V	1	16 lm	Required	£6.55
SE15090W4	2.4W	● 24V	4	16 lm	6W included	£42.74
SE15090W8	4.8W	● 24V	8	16 lm	6W included	£68.42

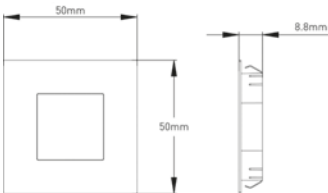

Cut out size: Ø44mm



Image shows how this product is wired to a driver

Each cable on the product is 1m



SPECTO

LED ROUND PLINTH LIGHT



- Stylish, discreet fitting. Stunning effect
- Ideal for use on kitchen plinth or in zone 2* of bathroom
- Each fitting runs at 0.32W
- Available individually or as a pack of 4 or 8
- 15mm fittings - very discreet
- 2 x 75cm cable per fitting for daisy chain connection
- Can be used with a range of Sensio switches and dimmers
- IP44 rated - protected against solid objects over 12mm (e.g. fingers) and protected against water drops at a 15 degree angle from the vertical



Specto LED Round Plinth Light - **Cool White (4000K)**

CODE	Wattage	Voltage	Qty	Lumens	Driver	RRP
SE15091C0	0.32W	● 24V	1	8 lm	Required	£5.88
SE15091C4	1.28W	● 24V	4	8 lm	6W included	£40.10
SE15091C8	2.56W	● 24V	8	8 lm	6W included	£63.16

Specto LED Round Plinth Light - **Warm White (3000K)**

CODE	Wattage	Voltage	Qty	Lumens	Driver	RRP
SE15091W0	0.32W	● 24V	1	8 lm	Required	£5.88
SE15091W4	1.28W	● 24V	4	8 lm	6W included	£40.10
SE15091W8	2.56W	● 24V	8	8 lm	6W included	£63.16

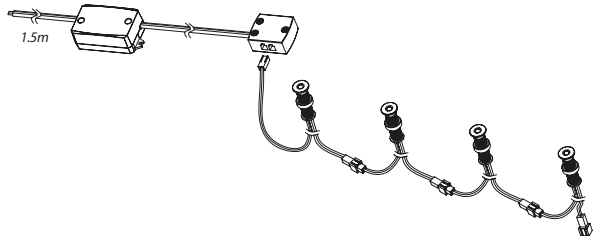
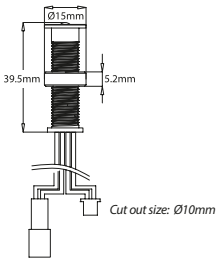

* The area stretching to 60cm outside the bath or shower and 60 cm from water outlet of sink. An IP rating of at least IP44 is required.

Image shows how this product is wired to a driver
Each cable on the product is 750mm



PURO

LED ROUND PLINTH LIGHT



- 2 x 1 m cables per fitting
- Available individually or as a pack of 4 or 8
- 15mm fittings - small size
- Fittings can be daisy chained together
- Can be used with a range of Sensio switches and dimmers



Puro LED Round Plinth Light - **Cool White (4000K)**

CODE	Wattage	Voltage	Qty	Lumens	Driver	RRP
SE15094C0	0.24W	● 24V	1	10 lm	Required	£5.24
SE15094C4	0.96W	● 24V	4	10 lm	6W included	£37.62
SE15094C8	1.92W	● 24V	8	10 lm	6W included	£58.18

Puro LED Round Plinth Light - **Warm White (3000K)**

CODE	Wattage	Voltage	Qty	Lumens	Driver	RRP
SE15094W0	0.24W	● 24V	1	10 lm	Required	£5.24
SE15094W4	0.96W	● 24V	4	10 lm	6W included	£37.62
SE15094W8	1.92W	● 24V	8	10 lm	6W included	£58.18

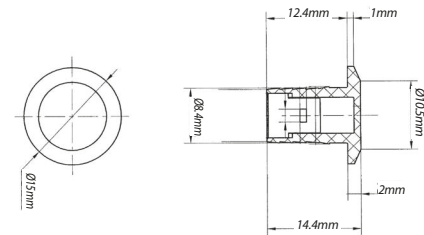

Cut out size: Ø11.8mm

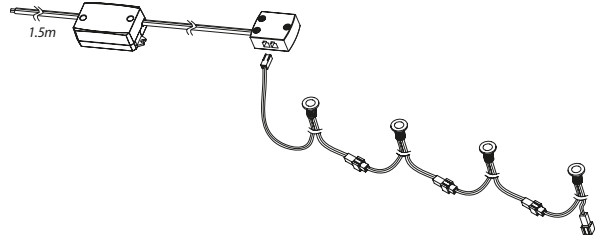

Image shows how this product is wired to a driver

Each cable on the product is 1m



NIMBUS

LED PLINTH LIGHT KIT



- Mood lighting for the kitchen or bathroom
- Ideal for use on kitchen plinths or in the bathroom
- All required components are included in the kit
- 2 x 500mm cables for each fitting
- 1.5m of mains cable from the driver
- Maximum walkover pressure is 100kg
- Also suitable for use in ceramic tiles, natural stone, hard wood and Quartz flooring
- Low energy consumption
- IP67 rated - Totally protected against the ingress of dust and protected against immersion in water (up to 30 mins between 15cm & 1m)



Nimbus LED Plinth Light Kit - **Cool White (5500K)**

CODE	Wattage	Cable	Qty	Lumens	Driver	RRP
SE35000C6.1	1.8W	1m PF*	6	22.8 lm	8W included	£53.30

* PF = per fitting

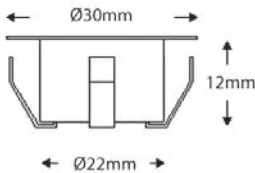

Cut out size: Ø24mm

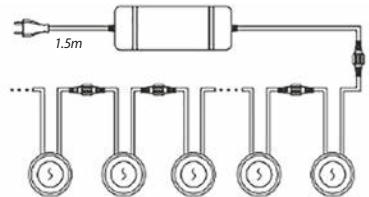

Image shows how this product is wired to a driver

Each cable on the product is 500mm





FLEXIBLE STRIP LIGHTING

- Extremely simple to use and can be used almost anywhere.
- Consider creating ambient mood lighting by using the flexible strip above wall units, along the plinth, under the worktop and even around a TV.

SIGMA

BENDABLE FLEXIBLE STRIP



• **Registered Design Right - 6024618**

- Innovation at its best - our brand new bendable flexible strip
- Strip has a unique PCB board cut in a 'zigzag' shape with amazing flexibility, allowing you bend the strip along 2 axes'
- Strip can be bent around 90 degree corners without the need for corner cables or starting a new run of strip
- Available in a 5000mm reel
- Self-adhesive 3M tape on back for installation
- The product can be cut to length with cut points every 100mm
- Can be cut and reused up to 50 times
- Uses the same connectors as the Primo range
- IP20 rated - protected against solid objects over 12mm (e.g. fingers)



Sigma Bendable Flexible Strip - **Cool White (5000K)**

Sigma Bendable Flexible Strip - **Warm White (3000K)**

CODE	Wattage	Voltage	Length	Qty	LEDs	Lumens	Driver	RRP	CODE	Wattage	Voltage	Length	Qty	LEDs	Lumens	Driver	RRP
SE10255C0	18W	● 24V	5000mm	1	300pcs	1990 lm	Required	£73.56	SE10255W0	18W	● 24V	5000mm	1	300pcs	1960 lm	Required	£73.56
SE10255C1	18W	● 24V	5000mm	1	300pcs	1990 lm	30W included	£113.02	SE10255W1	18W	● 24V	5000mm	1	300pcs	1960 lm	30W included	£113.02

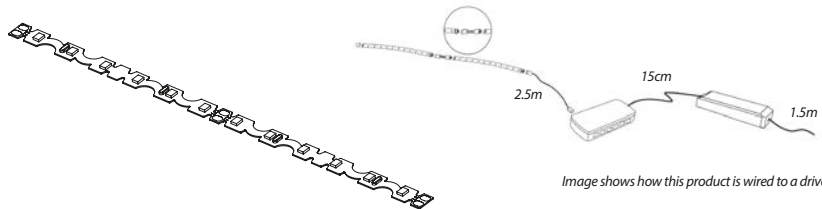
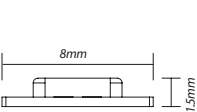

Image shows how this product is wired to a driver

Cable, Connectors and Accessories

CODE	DESCRIPTION	RRP
SE101080*	Sigma Driver Connection Cable - 2500mm <i>* Required to run the Sigma LED Flexible Strip</i>	£4.08
SE100050	Sigma Joining Clip	£1.44
SE100750	1.5m Joining Lead	£4.44
SE101050	Sigma Flexible Strip Corner Connector - 50mm	£2.40
SE9009	2.5m Extension Cable	£3.00





QUANTUM

DIFFUSED FLEXIBLE STRIP



- Entirely diffused flexible strip light with no visible LED points
- Supplied with clips and 3M adhesive so the product can be used along the plinth or under cabinets
- Developed so the product can be cut to length. Cut points are every 41mm so a precise length can be achieved (each strip can only be cut once and the cut piece is to be discarded)
- Strips have male and female connectors so can be seamlessly and very simply interlinked
- Each strip is supplied with an end cap to protect the female end or cut end of the strip
- The join between strips is almost seamless
- No more visible LED points on a glossy floor - achieve a truly seamless line for the first time
- IP20 rated - protected against solid objects over 12mm (e.g. fingers)



Quantum Diffused Flexible Strip - Cool White (5000K)

CODE	Wattage	Voltage	Length	Qty	LEDs	Lumens	Driver	RRP
SE20105C0	3W	● 24V	333mm	1	48	201 lm	Required	£24.36
SE20115C0	9W	● 24V	1000mm	1	144	600 lm	Required	£54.00
SE20115C1	9W	● 24V	1000mm	1	144	600 lm	30W included	£80.78

Quantum Diffused Flexible Strip - Warm White (3000K)

CODE	Wattage	Voltage	Length	Qty	LEDs	Lumens	Driver	RRP
SE20105W0	3W	● 24V	333mm	1	48	186 lm	Required	£24.36
SE20115W0	9W	● 24V	1000mm	1	144	558 lm	Required	£54.00
SE20115W1	9W	● 24V	1000mm	1	144	558 lm	30W included	£80.78

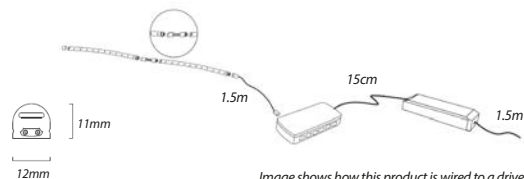
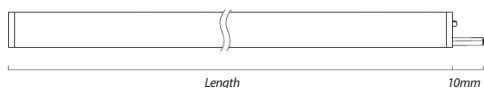

Image shows how this product is wired to a driver

Cables, Connectors and Accessories

CODE	DESCRIPTION	RRP
SE200570*	Quantum Strip Driver	£5.04
	Connection Lead - 1500mm	
* Required to run the Quantum Flexible Strip		
SE200050	50mm Corner Connection Cable	£4.20
SE200750	1500mm Joining Lead	£6.48



End cap connection



COMPACT MULTI-POINT LED FLEXIBLE STRIP



• **Registered Design Right - 6024617**

- Compact has the highest lumen output per metre of all the flexible strips
- More diodes, closer together - no dark spots
- Sleek finish
- Self-adhesive 3M tape on back for installation
- Male and female ends allow you to create required length
- Can be cut to length (every 50mm)
- Cut the strip ONCE and re-use the cut off section using cut joining connector
- Suitable for use in multiple areas - including Plinth, Over / Under Cabinet
- Run 10m from one 60W driver
- IP54 rated - Limited ingress of dust permitted (no harmful deposit) and protected against sprays from any angle, e.g. splashes of water



Compact Multi-Point Flexible LED Strip - **Cool White (5500K)**

Compact Multi-Point Flexible LED Strip - **Warm White (2900K)**

CODE	Wattage	Voltage	Length	Qty	Lumens	Driver	RRP	CODE	Wattage	Voltage	Length	Qty	Lumens	Driver	RRP
SE10845C0	3W	● 24V	500mm	1	333 lm	Required	£19.20	SE10845W0	3W	● 24V	500mm	1	311 lm	Required	£19.20
SE10815C0	6W	● 24V	1000mm	1	667 lm	Required	£27.42	SE10815W0	6W	● 24V	1000mm	1	623 lm	Required	£27.42
SE10815C1	6W	● 24V	1000mm	1	667 lm	15W included	£46.45	SE10815W1	6W	● 24V	1000mm	1	623 lm	15W included	£46.45
SE10825C0	12W	● 24V	2000mm	1	1334 lm	Required	£47.76	SE10825W0	12W	● 24V	2000mm	1	1246 lm	Required	£47.76
SE10825C1	12W	● 24V	2000mm	1	1334 lm	15W included	£72.43	SE10825W1	12W	● 24V	2000mm	1	1246 lm	15W included	£72.43

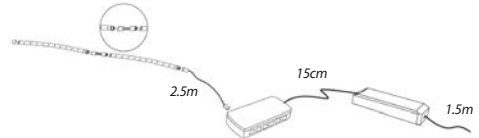
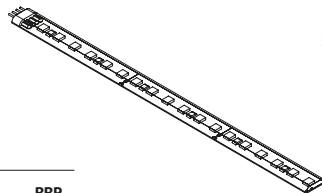
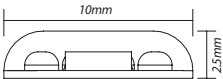

Image shows how this product is wired to a driver

Cables, Connectors and Accessories

CODE	DESCRIPTION	RRP
SE9009	2.5m Extension Cable	£3.00
SE90314HD*	HD LED Flexible Strip Driver Connection Lead - 2500mm	£3.11
* Required to run the Compact LED Flexible Strip		
SE90315HD	HD LED Flexible Strip Joining Lead - 500mm	£3.42
SE90316HD	HD LED Flexible Strip Corner Connection Lead - 50mm	£3.60
SE90317HD	HD LED Flexible Strip Cut Joining Connector	£1.44



SE9009



SE90314HD



SE90315HD



SE90316HD



SE90317HD



VIVA 2

MULTI LED FLEXIBLE STRIP

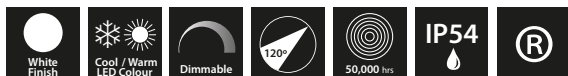

• Registered Design Right - 6024615

- Can be used almost anywhere
- Extremely low energy consumption, only 5W per 2000mm
- Self-adhesive 3M tape on back for installation
- Male and female ends allow you to create required length
- Can be cut to length (every 50mm)
- Cut the strip ONCE and re-use the cut off section using cut joining connector
- Suitable for use in multiple areas - including Plinth, Over / Under Cabinet
- IP54 rated - Limited ingress of dust permitted (no harmful deposit) and protected against sprays from any angle, e.g. splashes of water



Viva Multi LED Flexible Strip - Cool White (5350K)



Viva Multi LED Flexible Strip - Warm White (2900K)



CODE	Wattage	Voltage	Length	Qty	Lumens	Driver	RRP	CODE	Wattage	Voltage	Length	Qty	Lumens	Driver	RRP
SE10645C0	1.25W	● 24V	500mm	1	149 lm	Required	£13.52	SE10645W0	1.25W	● 24V	500mm	1	139 lm	Required	£13.52
SE10615C0	2.5W	● 24V	1000mm	1	298 lm	Required	£22.20	SE10615W0	2.5W	● 24V	1000mm	1	278 lm	Required	£22.20
SE10615C1	2.5W	● 24V	1000mm	1	298 lm	15W included	£41.28	SE10615W1	2.5W	● 24V	1000mm	1	278 lm	15W included	£41.28
SE10625C0	5W	● 24V	2000mm	1	596 lm	Required	£38.88	SE10625W0	5W	● 24V	2000mm	1	556 lm	Required	£38.88
SE10625C1	5W	● 24V	2000mm	1	596 lm	15W included	£57.62	SE10625W1	5W	● 24V	2000mm	1	556 lm	15W included	£57.62

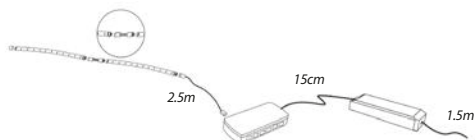
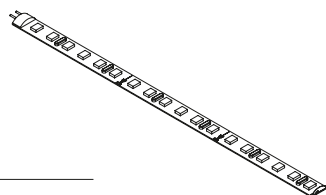
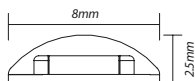

Image shows how this product is wired to a driver

Cables, Connectors and Accessories

CODE	DESCRIPTION	RRP
SE9009	2.5m Extension Cable	£3.00
SE10314*	LED Flexible Strip Driver	£3.19
	Connection Lead - 2500mm	
	* Required to run the Viva LED Flexible Strip	
SE10316	LED Flexible Strip Corner Connection Lead - 50mm	£2.50
SE10317	LED Flexible Strip Joining Lead - 1500mm	£2.40
SE10318MCC	LED Flexible Strip Cut Joining Connector	£3.00



SE9009



SE10314



SE10316



SE10317



SE10318MCC



PRIMO 2

5M CLIP LED FLEXIBLE STRIP



• Registered Design Right - 6024616

- Can be cut and re-used up to 50 times
- Illuminate several areas of a room with one strip
- Self-adhesive 3M tape on the back of the fitting for installation
- Supplied as 5m reel
- Can be cut to length (every 100mm)
- Suitable for multiple areas - including plinth, over / under cabinet
- IP20 rated - protected against solid objects over 12mm (e.g. fingers)



Primo 5m Clip LED Flexible Strip - Cool White (5000K)

Primo 5m Clip LED Flexible Strip - Warm White (3000K)

CODE	Wattage	Voltage	Length	Qty	Lumens	Driver	RRP	CODE	Wattage	Voltage	Length	Qty	Lumens	Driver	RRP
SE10755C0	18W	● 24V	5m	1	1990 lm	Required	£58.80	SE10755W0	18W	● 24V	5m	1	1985 lm	Required	£58.80
SE10755C1	18W	● 24V	5m	1	1990 lm	30W included	£98.54	SE10755W1	18W	● 24V	5m	1	1985 lm	30W included	£98.54

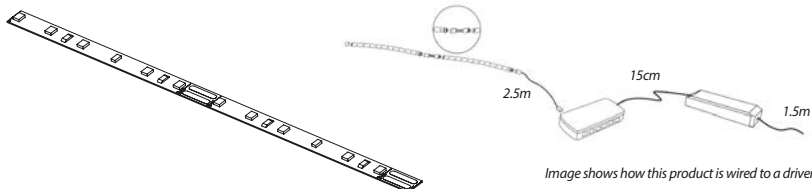
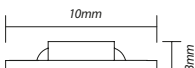

Image shows how this product is wired to a driver

Cable, Connectors and Accessories

CODE	DESCRIPTION	RRP
SE101080*	Primo Driver Connection Cable - 2500mm	£4.08
* Required to run the Primo LED Flexible Strip		
SE100050	Primo Joining Clip	£1.44
SE100750	1.5m Joining Lead	£4.44
SE101050	Primo Flexible Strip Corner Connector	£2.40
SE9009	2.5m Extension Cable	£3.00





DUOFLEX

DUAL COLOUR FLEXIBLE STRIP



• Registered Design Right - 6024620

- Seamlessly mix colour to create the perfect mood
- Can be easily alternated between cool white, natural white and warm white, and anything in between
- Self-adhesive 3M tape on back for installation
- Male and female ends allow you to create required length
- Can be cut to length (every 100mm)
- Cut the strip ONCE and that will create the end of the run. The cut piece with female end cannot be reused
- Operate using a 3-in-1 remote control or Sensio Multi-Light App
- One remote will control all receivers within 15m radius
- Maximum length of 6m can be run from each receiver
- 10 brightness levels
- Dims and brightens in 10% increments
- IP54 rated - Limited ingress of dust permitted (no harmful deposit) and protected against sprays from any angle, e.g. splashes of water



Duoflex Dual Colour Flexible Strip - (2700K -5000K)

CODE	Wattage	Voltage	Length	Qty	Lumens	Driver	RRP
SE10445D0	2.5W	● 24V	500mm	1	195 lm	Required	£20.02
SE10425D0	10W	● 24V	2000mm	1	780 lm	Required	£57.72
SE10425D1.1*	10W	● 24V	2000mm	1	780 lm	15W included	£156.95

* Includes the driver, driver lead, receiver and remote control



Cool white and warm white diodes side by side creating natural white

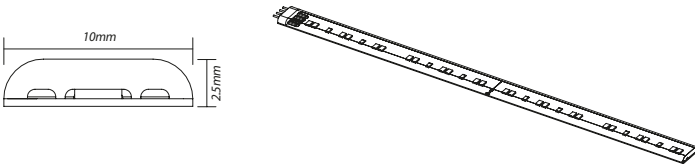

Cables and Connectors

CODE	DESCRIPTION	RRP
SE10325*	Driver Connection Lead - 2500mm	£5.94
* One Driver Lead is required for each run of the DuoFlex		
SE10328	DuoFlex Joining Lead - 500mm	£3.12
SE10327	DuoFlex Corner Connection Lead - 50mm	£3.59





Warm white 2700K

Natural white 4000K

Cool white 5000K

RGB

COLOUR CHANGING FLEXIBLE STRIP

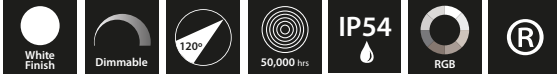

• **Registered Design Right - 6024619**

- 7 colours, 3 effects
- Pre-set colours available
- Great for mood lighting
- Function available to cycle through colours
- Cycle can be slow or quick colour change
- Self-adhesive 3M tape on back for installation
- Male and female ends allow you to create required length
- Can be cut to length (every 100mm)
- Operate using the 3-in-1 Remote Control or Sensio Multi-Light App
- One remote will control all receivers within 15m radius
- Multiple receivers can be controlled by one remote
- Maximum length of 12m from a 60W Driver
- IP54 rated - Limited ingress of dust permitted (no harmful deposit) and protected against sprays from any angle, e.g. splashes of water



RGB Colour Changing Flexible Strip

CODE	Wattage	Voltage	Length	Qty	Lumens	Driver	RRP
SE10245R0	2.5W	● 24V	500mm	1	165 lm	Required	£16.24
SE10225R0	10W	● 24V	2000mm	1	660 lm	Required	£54.24
SE10225R1.1*	10W	● 24V	2000mm	1	660 lm	15W included	£146.94

* Includes the driver, driver lead, receiver and remote control

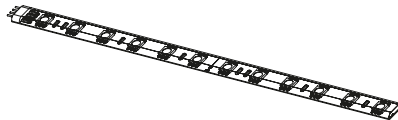
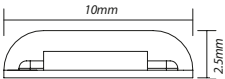

Cables, Connectors and Accessories

CODE	DESCRIPTION	RRP
SE10325*	Driver Connection Lead - 2500mm	£5.94
* Required to run the RGB LED Flexible Strip		
SE10328	LED RGB Flexible Strip Joining Lead - 500mm	£3.12
SE10327	LED RGB Flexible Strip Corner Connection Lead - 50mm	£3.59





SENSIO MULTI-LIGHT APP BLUETOOTH RECEIVERS



- Control any Sensio lighting product from a smart phone or tablet device

How it works:

- Plug the relevant receiver for your light into a driver
 - *A receiver is required for any product you would like to control using the App
- Download 'Sensio Multi Light' from the Apple Store (free download)
- Switch all lighting you wish to control on
- Follow the Sensio instructions to configure your preferred settings

Features:

- On/off switch
- Single product selection - control each light/light area individually
- Group lighting - group all/some of your lighting to be controlled together
- Your settings - set up lighting areas and control each separately
- RGB lighting will change colour to the sound of your music



SE792990

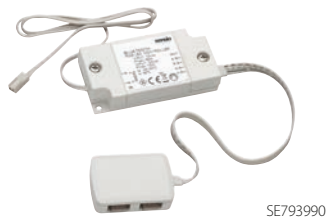

SE793990



SE794990

Sensio Multi-Light App Bluetooth Receivers

CODE	Description	Wattage	Qty	RRP
SE792990	Single Colour LED	72W*	1	£32.40
SE793990	RGB LED	72W*	1	£35.40
SE794990	Duo Colour LED	72W*	1	£31.92

*Maximum (based on use with 24V products)

Driver(s) to be purchased separately. Detection range of the receivers is ≤ 10m. The App can pair with up to 4 receivers.

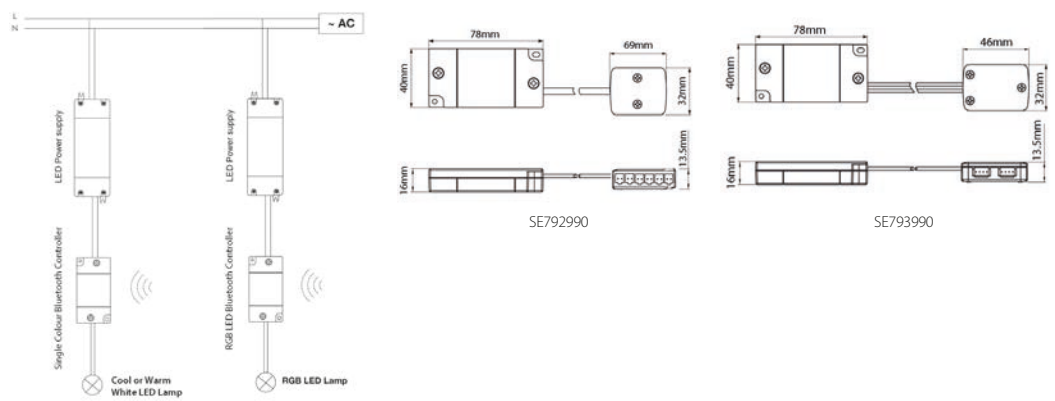

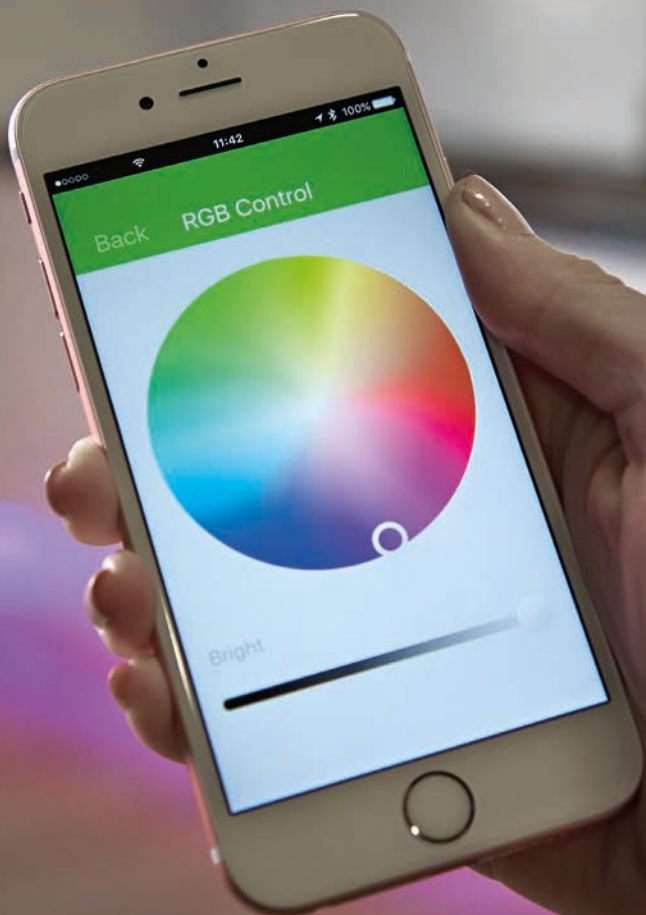

SENSIO MULTI-LIGHT MOBILE LIGHTING CONTROL

- Multiple light type control (single colour, RGB, TrioTone & CCT)
- Simple installation, now or later (can be retrofit)
- Easy to use. FREE iOS App
- No more remotes, control all lighting from one app
- Simple navigation





INTEGRATED SOLUTIONS & PROFILES

- Available in a variety of lengths.
- We offer a surface mounted or recessed aluminium profile with a frosted diffuser.
- Our angled profile can be used to introduce wide angled light to edges and corners of internal units, or for use under cabinets for a discreet solution.
- Integrated solutions are perfect for a more flush appearance



CONTOUR

UNDER WORKTOP PROFILE



Registered Design Right - 6037414

- Ideal for contemporary kitchen designs with handleless cabinets
- Compatible with Sensio flexible LED strips and has a opaque diffused lens so that no individual diodes are visible
- Available in 1.5m and 2.5m lengths
- Can be cut to any desired length
- Includes internal and external connects which are optional extras



Contour Under Worktop Profile

CODE	Length	Qty	RRP
SE98210	1500mm	1	£20.92
SE98220	2500mm	1	£34.87

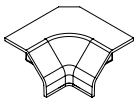

Internal corner connector

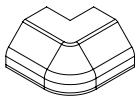

External corner connector

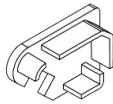

End cap

Cables, Connectors and Accessories

CODE	DESCRIPTION	RRP
SE97990	1 x External Corner Connector	£3.66
SE97890	1 x Internal Corner Connector	£3.66
SE97790	1 x Left End Cap & 1 x Right End Cap	£3.00



MANTA

INTEGRATED HANDLESS PROFILE



- Available in 8 lengths
- True integrated handless profile
- Diffused LED strip points up and down providing internal/under cabinet lighting
- Aluminium finish



Manta Integrated Handless Profile - **Cool White (4500K)**

CODE	Wattage	Voltage	Length	Qty	Lumens	Driver	RRP
SE27012C0	6.4W	● 24V	361mm	1	503 lm	Required	£27.30
SE27112C0	7.4W	● 24V	411mm	1	570 lm	Required	£29.53
SE27212C0	8.4W	● 24V	461mm	1	666 lm	Required	£31.76
SE27312C0	10.3W	● 24V	561mm	1	808 lm	Required	£35.45
SE27412C0	14.3W	● 24V	761mm	1	1070 lm	Required	£44.28
SE27512C0	15.4W	● 24V	861mm	1	1225 lm	Required	£48.00
SE27612C0	17.3W	● 24V	961mm	1	1322 lm	Required	£53.90
SE27712C0	21.1W	● 24V	1161mm	1	1606 lm	Required	£62.00

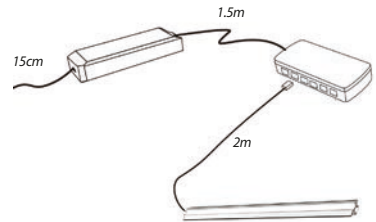
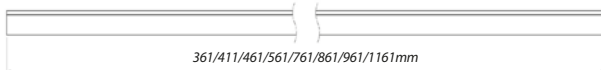
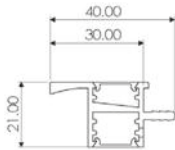

Image shows how this product is wired to a driver



BEAM

ANGLED ALUMINIUM PROFILE



- Angled to spread evenly diffused light
- Available in 2.2m and 1m lengths
- 16mm x 16mm
- All Sensio flexible strips will fit inside the profile (10mm inner channel)
- Silver finished end caps
- Hole in the end cap is adequate size to fit a JB4 connector, allowing use with the Primo, Compact and Viva
- Suitable for use with the Duoflex and RGB, simply adapt the hole in the end cap
- Supplied with one cut out end cap and one with no cut-out for a neat finish
- Opal PC cover to diffuse the LED points
- Mounting brackets and end caps supplied with each profile
- Additional mounting brackets and end caps will be sold separately in sets of 2



Beam Angled Aluminium Profile

CODE	Length	Qty	RRP
SE982120	1000mm	1	£12.23
SE982220	2200mm	1	£25.96

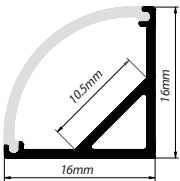

Cables, Connectors and Accessories

CODE	DESCRIPTION	RRP
SE983050	Additional End Cap Set for Angled Aluminium Profile	£1.01
SE984050	Additional Mounting Bracket Set for Angled Aluminium Profile	£1.01



SE983050

SE984050



LINIA

RECESSED ALUMINIUM PROFILE



- Flush fit for a minimalist look
- Aluminium finish
- Houses all Sensio flexible strips
- Flexible and easy to install
- End caps protrude to fill the gap in furniture when cut with a router for neat finish
- End caps supplied with each profile (2 with the 1m, 4 with the 2.2m)
- Perfect for use under cabinets, inside larders or inside wardrobes
- Streamlined finish



Linia Recessed Aluminium Profile

CODE	Length	Qty	RRP
SE980120	1000mm	1	£12.35
SE980220	2200mm	1	£24.95

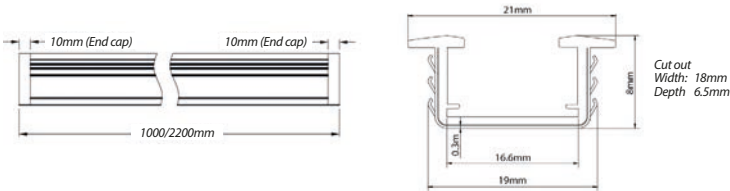

Cables, Connectors and Accessories

CODE	DESCRIPTION	RRP
SE980050	2 x End Caps for Recessed Profile	£0.89



SE980050



FINO

SURFACE MOUNTED ALUMINIUM PROFILE



- Customisable lighting
- Aluminium finish
- Houses all Sensio flexible strips
- Flexible and easy to install
- End caps and mounting brackets supplied with each profile (2 with the 1m, 4 with the 2m)
- Can be cut to length
- Perfect for use inside cabinets, larders or wardrobes
- Streamlined finish



Fino Surface Mounted Profile

CODE	Length	Qty	RRP
SE981120	1000mm	1	£11.84
SE981220	2000mm	1	£22.31

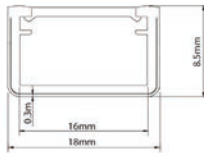
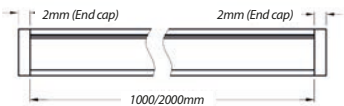

Cables, Connectors and Accessories

CODE	DESCRIPTION	RRP
SE982050	2 x End Caps for Surface Mounted Profile	£ 0.89
SE981050	2 x Mounting Brackets for Surface Mounted/ Recessed Profile	£0.48



SE982050



SE981050



A close-up photograph of a modern kitchen cabinet. The cabinet is dark grey or black with a brushed metal finish. A pull-out drawer is extended, revealing a battery lighting unit inside. The unit is white and has a wooden surface on top. The lighting is soft and focused on the drawer area. The background is slightly blurred, showing the rest of the cabinet and a wooden countertop.

BATTERY LIGHTING

- Convenient, easy to install and discreet.
- No wiring necessary.



DOMA

BATTERY POWERED SPOT LIGHT



- Quick and simple to install. No wiring required
- Diffuser conceals all visible LED points
- Powered by 3 x AA batteries (not included)
- Push the centre of the fitting to switch the light on/off
- Auto power off after 10 minutes
- Battery lifetime: 6 months when used 3 times per day for 5 minutes each time



Doma Battery Powered Spot Light - **Warm White (3000K)**

CODE	Wattage	Power Supply	Qty	Lumens	RRP
SE11009W0	0.75W	3 x AA batteries	1	70 lm	£14.38

* Requires 3 x AA batteries (not included). Comes in coloured packaging.

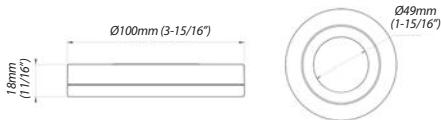



OPAL

BATTERY POWERED LED LIGHT



- Quick and simple to install. No wiring required
- Diffuser conceals all visible LED points
- Powered by 3 x AA batteries (not included)
- Built-in on/off switch with dimming function
- Functions: on at full brightness, 50% brightness and off
- Neat and simple solution, suitable for any kitchen
- Auto powers off after 10 minutes
- Battery lifetime - 1 year when used 3 times per day for 5 minutes



Opal Battery Powered LED Light - **Warm White (3000K)**

CODE	Wattage	Length	Power Supply	Qty	Lumens	RRP
SE10154W0	1.2W	251mm	3 x AA batteries	1	84 lm	£29.64

* Requires 3 x AA batteries (not included). Comes in coloured packaging.

